

ECLIPSE 600D

LED MIRROR

SPECIFICATIONS

WIDTH	600mm
HEIGHT	600mm
DEPTH	33mm
WEIGHT	9kg

LIGHTING SPECIFICATIONS

CCT	2700K - 6500K
CRI	>80

INSTALLATION

Wall mount
Hardwire
Input voltage: 220-240v 50Hz

FEATURES

Copper Free Mirror
LED Lighting (Adjustable Colour Temperature)
Frontlit
Touch Sensor
Demister with 1 Hour Auto Cut-off

FINISHES

Matt White MDF Frame	
Matt Black MDF Frame	

PRODUCT CODE

E60D-MW
E60D-MB

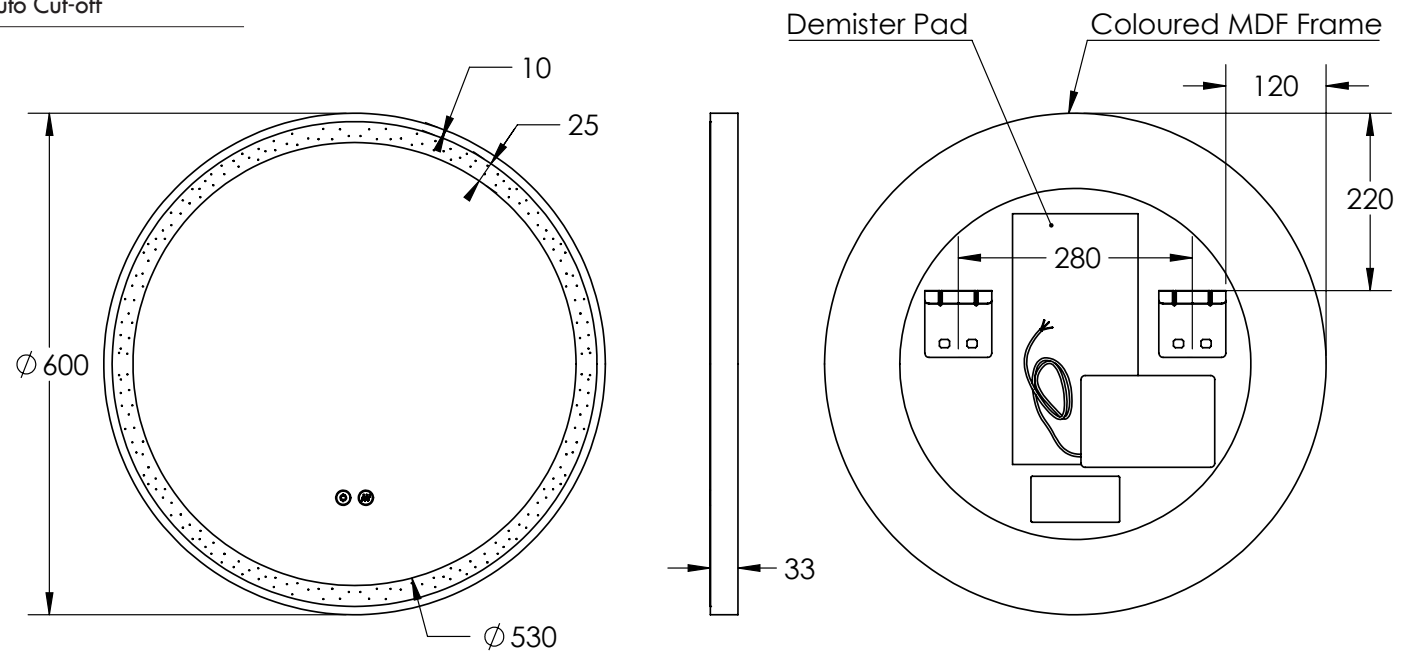

Disclaimer: All LED Products requiring hardwiring must be installed by a licensed electrician in accordance with local regulations. Sizes are in mm and nominal and should be checked prior to installation. Actual colours may vary so please check colour samples before ordering. Installation is acceptance of our products. Installation of faulty, warped, chipped or damaged products will void our warranty.