

# MIRO 1500DB

## LED MIRROR

PRODUCT CODE

M150DB

### SPECIFICATIONS

WIDTH	1500mm
HEIGHT	750mm
DEPTH	59mm
WEIGHT	20kg

### FEATURES

Copper Free Mirror
LED Lighting (Adjustable Colour Temperature)
Backlit
Touch Sensor
Demister with 1 Hour Auto Cut-off
Bluetooth Speakers

### LIGHTING SPECIFICATIONS

CCT	2700K - 6500K
CRI	>80

### INSTALLATION

Wall mount
Hardwire
Input voltage: 220-240v 50Hz

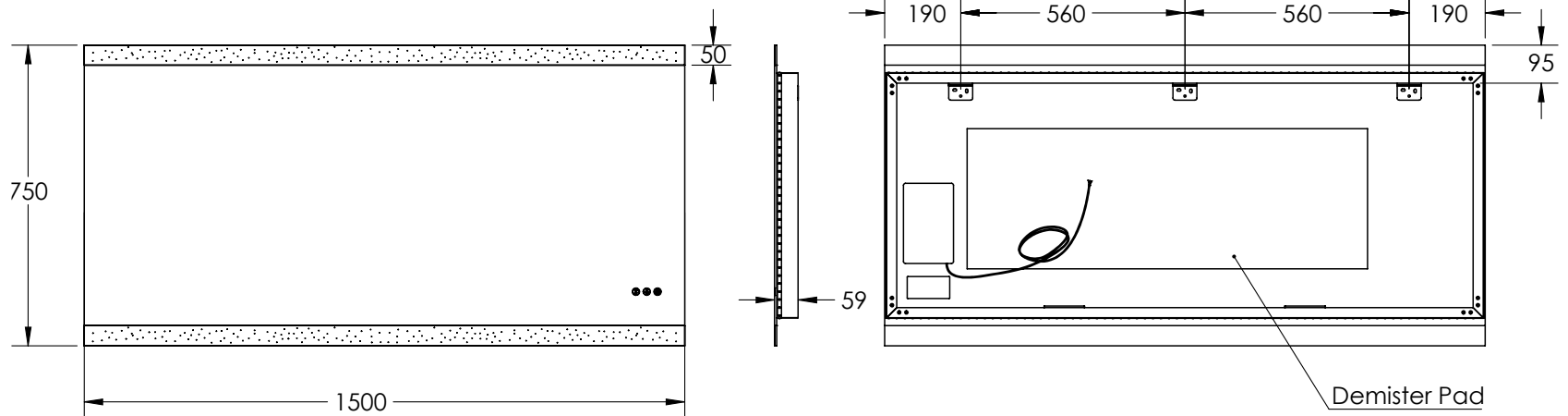

Disclaimer: All LED Products requiring hardwiring must be installed by a licensed electrician in accordance with local regulations. Sizes are in mm and nominal and should be checked prior to installation. Actual colours may vary so please check colour samples before ordering. Installation is acceptance of our products. Installation of faulty, warped, chipped or damaged products will void our warranty.